



YDS-OIS15-FF-OV5648

5MP OmniVision OV5648 OIS MGS MIPI Interface Fixed Focus Camera Module



Front View



Back View

Specifications

Camera Module No.	YDS-OIS15-FF-OV5648
Resolution	5MP
Image Sensor	OV5648 w/ MGS OIS
Sensor Type	1/4"
Pixel Size	Fixed Focus
EFL	3.63 mm
F.NO	1.80
Pixel	2592 x 1944
View Angle	65.0°(DFOV)
Lens Dimensions	15.40 x 15.40 x 4.50 mm
Module Size	35.50 x 15.40 mm
Module Type	Fixed Focus
Interface	MIPI
Auto Focus VCM Driver IC	None
Lens Type	650nm IR Cut
Operating Temperature	-30°C to +70°C
Mating Connector	BAF04-30083-0500



YDS-OIS15-FF-OV5648

5MP OmniVision OV5648 OIS MGS MIPI Interface Fixed Focus Camera Module



Top View



Side View



Bottom View

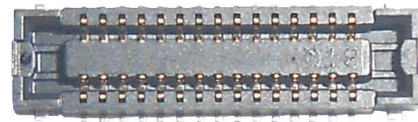

Mating Connector

RoHS

PIN	SIGNAL
1	VCM_GND
2	VCM_GND
3	VCM_3.3V
4	SDA
5	SCL
6	GND
7	MCN
8	MCP
9	MDN0
10	MDP0
11	MDN1
12	MDP1
13	TooIQ(NC)
14	MDN2
15	MDP2
16	MDN3
17	MDP3
18	AGND
19	AVDD_2.8V
20	VCM_3.3V
21	DGND
22	MCLK
23	DGND
24	RESET
25	PWDN
26	DVDD_1.2V
27	VDDIO_1.8V
28	Reset_N(GPIO)
29	DRV_AVDD3.3V
30	DGND

Version	Information	Date
V1.0	First Version	9-13-2022
V2.0	Changing the FPC	11-13-2022

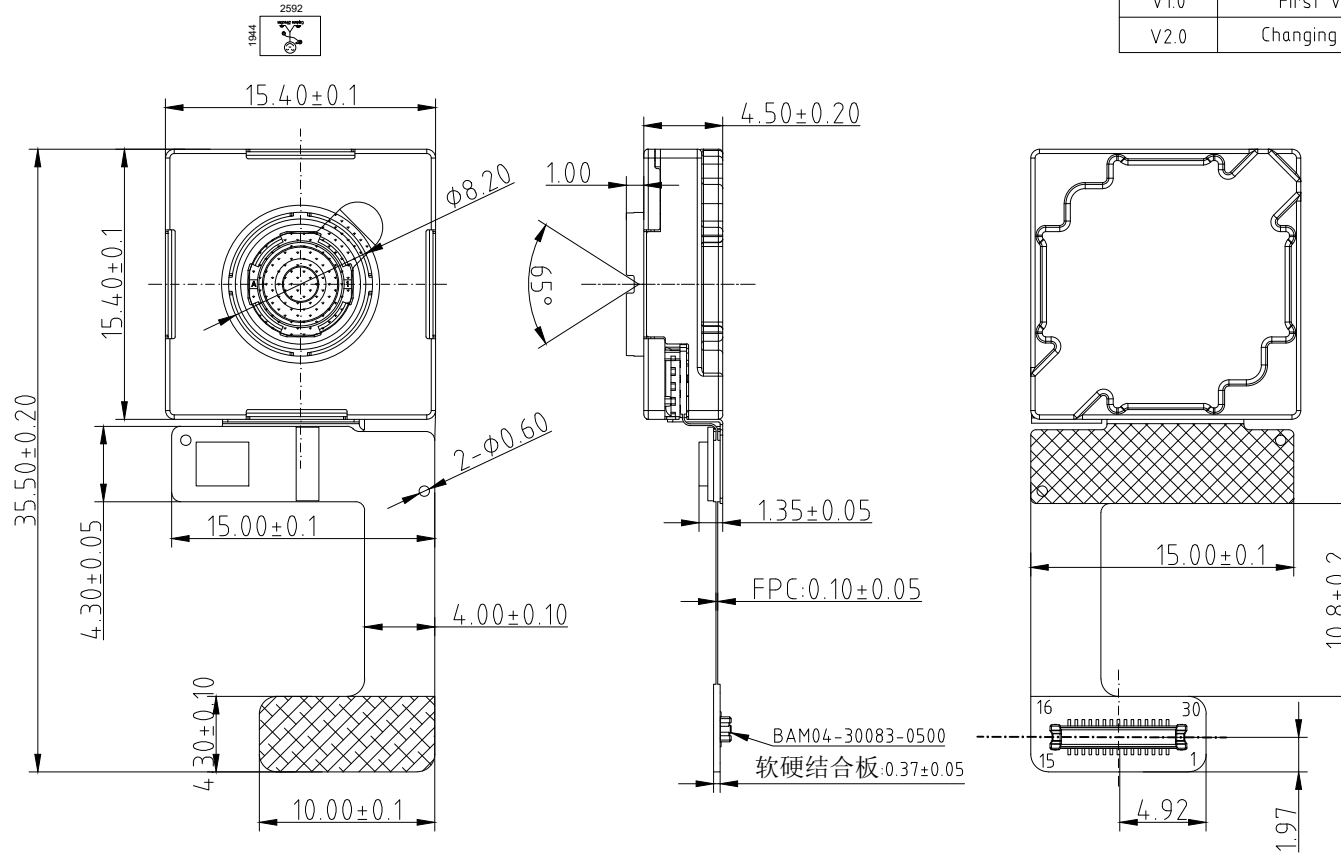

TOP VIEW

SIDE VIEW

BOTTOM VIEW

Parameter:

1、Sensor specification:

Image Sensor: OV5648

Pixel: $1.4\mu\text{m} \times 1.4\mu\text{m}$

Lens Type: 1/4

Important Voltage Description:

2、Lens specification:

FOV: 65°

F/N0: 1.8

TV distortion: $<1.0\%$

Focal length: 3.63mm

Composition: 5P+ IR FILTER

IR Cut Coating: $650\text{nm} \pm 10\text{nm} @ 50\%$

Designed By

Kevin

Model Name:

OIS15-FF-OV5648 V2.0

Checked By

Aouly_Yan

Projection Type:

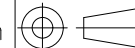

Third Angle

Unit:

mm

Scale:

1:1

Material:

Sheet:

1 of 1

Version:

1/0

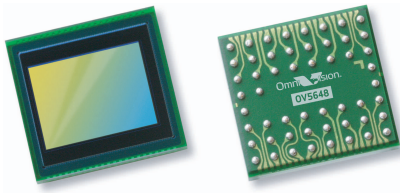

OV5648 5-megapixel product brief



Cost-Efficient 5-Megapixel Camera Solution for Mainstream Mobile Devices



available in
a lead-free
package

The OV5648 is a cost-efficient, high performance 5-megapixel CameraChip™ sensor for smartphones and tablets. Utilizing OmniVision's latest 1.4-micron OmniBSI+™ pixel architecture, the OV5648 combines a reduced die size with improved quality photography and high-definition (HD) video, making it ideally suited for mainstream mobile applications.

OmniVision's powerful new OmniBSI+ pixel architecture offers significant performance improvements over our original OmniBSI™ architecture, including a 60 percent increase in full-well capacity and a significant improvement in low-light sensitivity. With OmniBSI+, the 1/4-inch OV5648 is capable of capturing high quality still images as well as 720p HD video at 60 frames per second (fps) and 1080p HD video at 30 fps.

The sensor supports a two-lane MIPI interface, and provides full-frame, windowed or binned 10-bit images in RAW RGB format with complete user control over

formatting and output transfer. It offers defective pixel canceling and all required automatic image control functions, including automatic exposure control, automatic gain control, automatic white balance, and automatic black level calibration.

A secondary image sensor may be connected to the OV5648 enabling a Video-in-Video (ViV) feature in which the secondary image is overlaid to the OV5648 output video. The combined video is streamed out over the MIPI interface. A bypass mode allows a secondary sensor to utilize the OV5648 MIPI interfaced baseband.

The OV5648 can fit into a 6 x 6 mm fixed focus camera module with a z-height of less than 4.5 mm.

Find out more at www.ovt.com.

Applications

- Cellular and Picture Phones
- PC Multimedia
- Toys
- Digital Still Cameras

Product Features

- 1.4 μm x 1.4 μm pixel with OmniBSI™ technology for high performance (high sensitivity, low crosstalk, low noise)
- optical size of 1/4"
- automatic image control functions:
 - automatic exposure control (AEC)
 - automatic gain control (AGC)
 - automatic white balance (AWB)
 - automatic black level calibration (ABLC)
- programmable controls for frame rate, AEC/AGC 16-zone size/position/weight control, mirror and flip, cropping, windowing, and panning
- defective pixel canceling
- support for output formats: 8-/10-bit raw RGB data
- support for video or snapshot operations
- support for LED and flash strobe mode
- support for internal and external frame synchronization for frame exposure mode
- support for horizontal and vertical sub-sampling
- standard serial SCCB interface
- MIPI interface (two lanes)
- Video-in-Video (ViV) and bypass support for secondary sensor
- 32 bytes of embedded one-time programmable (OTP) memory
- on-chip phase lock loop (PLL)
- embedded 1.5V regulator for core power
- programmable I/O drive capability, I/O tri-state configurability
- support for black sun cancellation

OV5648

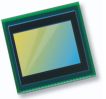

Ordering Information

- OV05648-A53A**
(color, lead-free, 53-pin CSP3)
- OV05648-G04A**
(color, chip-probing, 200 μm backgrinding, reconstructed wafer)

Product Specifications

- active array size:** 2592 x 1944
- power supply:**
 - core: 1.5V \pm 5% (with embedded 1.5V regulator)
 - analog: 2.6 - 3.0V (2.8V typical)
 - I/O: 1.7 - 3.0V
- power requirements:**
 - active: 219 mW
 - standby: 36 μW
- temperature range:**
 - operating: -30°C to 70°C junction temperature
 - stable image: 0°C to 50°C junction temperature
- output formats:** 8-/10-bit RGB RAW output
- lens size:** 1/4"
- lens chief ray angle:** 29.1°
- input clock frequency:** 6 - 27 MHz
- max S/N ratio:** 36 dB
- dynamic range:** 72 dB @ 8x gain
- maximum image transfer rate:**
 - QSVGA (2592x1944): 15 fps
 - 1080p: 30 fps
 - 960p: 45 fps
 - 720p: 60 fps
 - VGA (640x480): 90 fps
- sensitivity:** 690 mV/lux-sec
- shutter:** rolling shutter
- pixel size:** 1.4 μm x 1.4 μm
- dark current:** 0.7 mV/s @ 50°C junction temperature
- image area:** 3673.6 μm x 2738.4 μm
- package/die dimensions:**
 - CSP3: 5010 μm x 4810 μm
 - COB: 5000 μm x 4800 μm

Functional Block Diagram

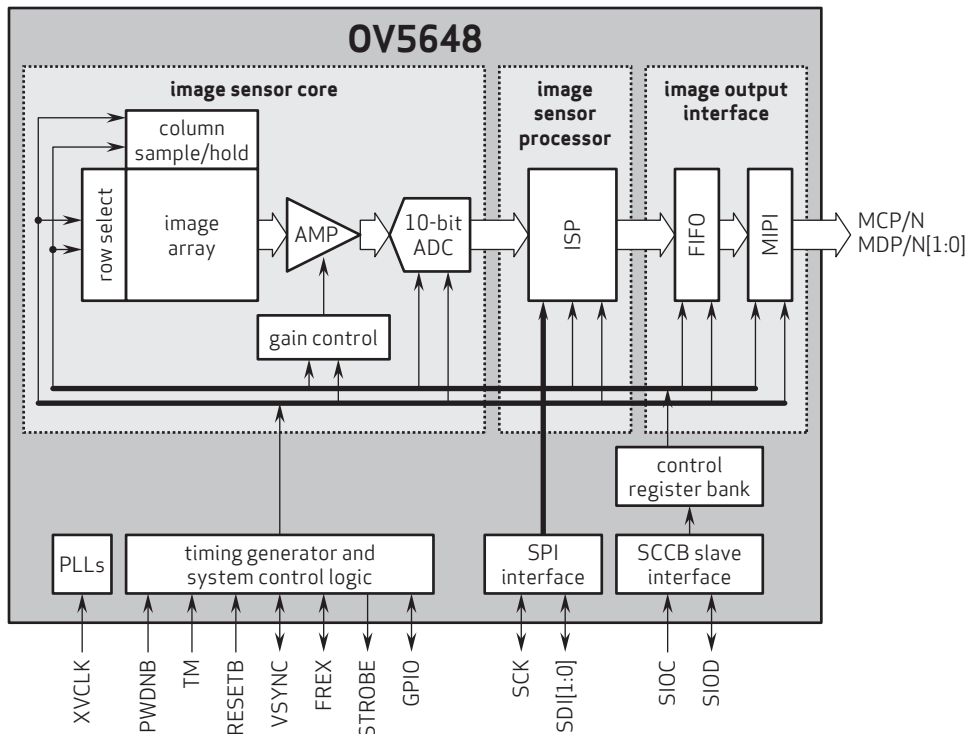

4275 Burton Drive
Santa Clara, CA 95054
USA

Tel: +1 408 567 3000
Fax: +1 408 567 3001
www.ovt.com

OmniVision reserves the right to make changes to their products or to discontinue any product or service without further notice. OmniVision, the OmniVision logo and VarioPixel are registered trademarks of OmniVision Technologies, Inc. CameraChip and OmniBSI+ are trademarks of OmniVision Technologies, Inc. All other trademarks are the property of their respective owners.

OmniVision

Micro Gimbal Stabilizer (MGS) OIS Camera Modules

Micro Gimbal Stabilizer (MGS) is the patented mechanical optical image stabilizer (OIS) for camera modules. The MGS technology is tilting the image sensor and lens together, enabling anti-shaking performance for moving devices to take a sharp and clear image, even in the low light environment.

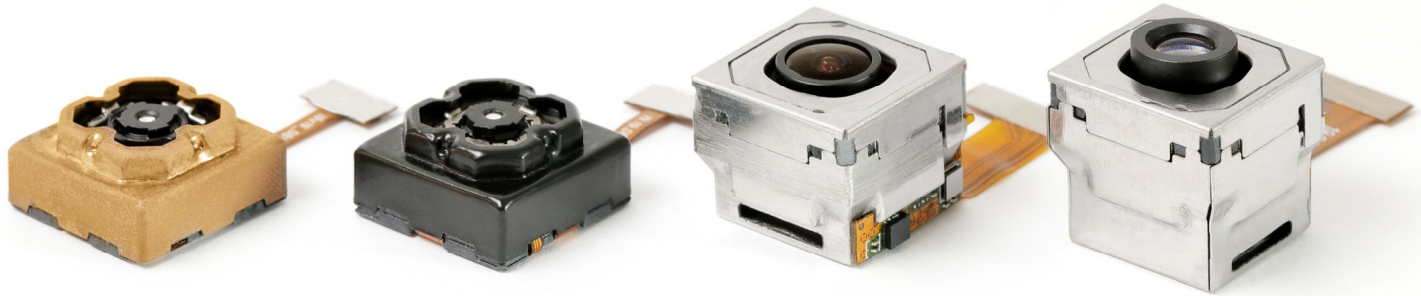

Features

2-Axis Compensation
Small, Light Weight
18.80x18.80x15.80mm

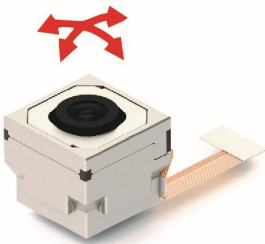

Smallest
Gimbal

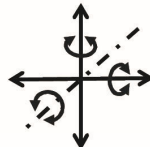

Multi-Axis
Compensation

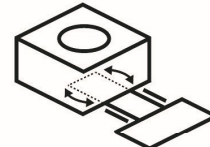

Embedded
Moving FPC



One-stop
Solution



Stabilizer



Max. View Angle



Integrated
Design



Patents

Applications



**5G Smart
Helmet**



**Sport
Camera**



Drones



Robots



**Wearable
Cameras**

Micro Gimbal Stabilizer (MGS) for Mobile Phones

Micro Gimbal Stabilizer (MGS) is fitting in the compact size, enabling the smartphones and tablet PC to take clear images in the moving environment.

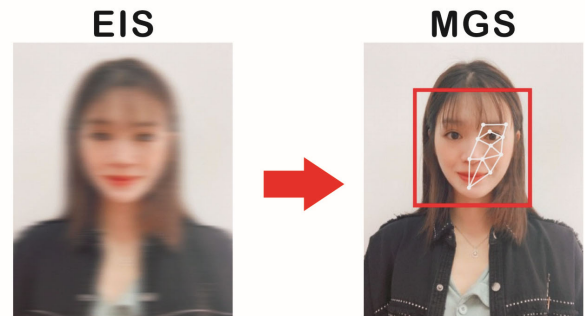
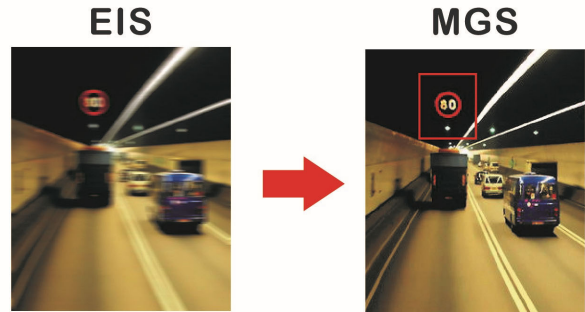
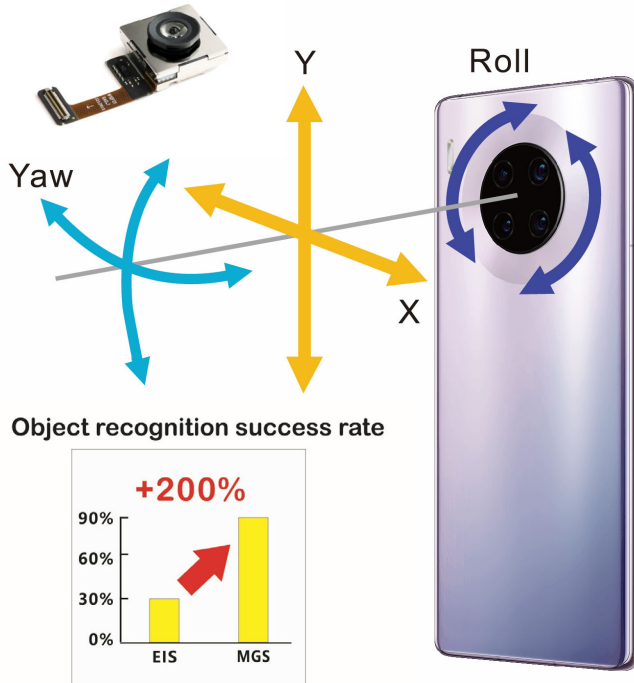

MGS camera significantly reduces

blurry in low light environment, and supports dynamic face and object recognition with 2 times faster rate.



REV.	Q'TY	ECN. NO.	APR.	DATE
A	--	RC-12-2-019	Juson Su	2012.08.07

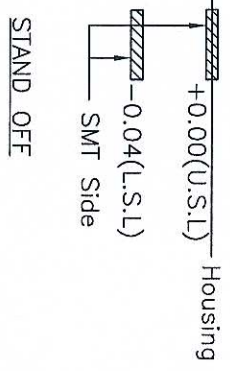
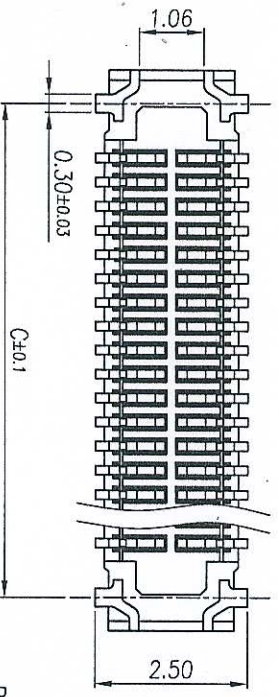
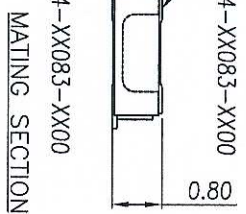
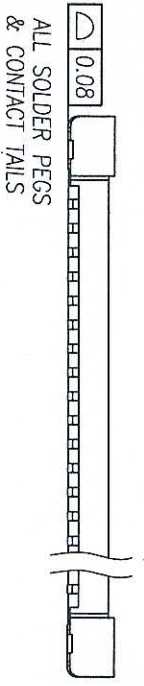
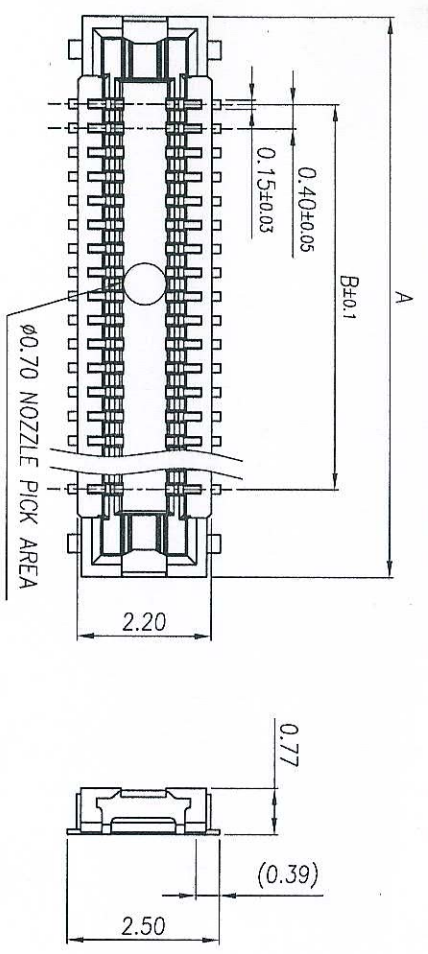

- NOTES:
- MATERIAL:
 - HOUSING: THERMOPLASTIC,U94 V-0,BLACK;
 - CONTACT: COPPER ALLOY, T=0.08mm
 - FINISH:
 - CONTACT: Au 5u" MIN PLATING ON CONTACT AREA, Au 1u" MIN. PLATING ON SOLDER TAIL, 50u" MIN. NICKEL UNDERPLATING OVER ALL
 - PRODUCT SPECIFICATIONS:
 - VOLTAGE RATING: 60V AC/DC
 - CURRENT RATING: 0.3A/CONTACT(MAX. 5A AT TOTAL CONTACT)
 - INSULATION RESISTANCE: 100MEG.OHM MIN(INITIAL)
 - WITHSTANDING VOLTAGE: 150V AC FOR 1 MINUTE
 - CONTACT RESISTANCE: 70 MILL.OHM MAX PER PIN INITIAL, AFTER CONDITION ΔR=20 MILL.OHM Max.
 - OPERATION TEMPERATURE: -55° TO +85°
 - MATING FORCE: 120g Max./POS.
 - UNMATING FORCE: 15g Min./POS.
 - DURABILITY: 30 CYCLES
 - PART NO: BAF04-XX083-0500

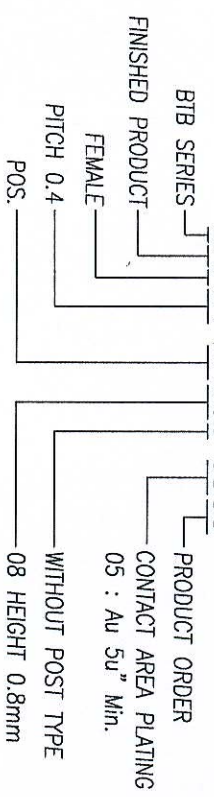
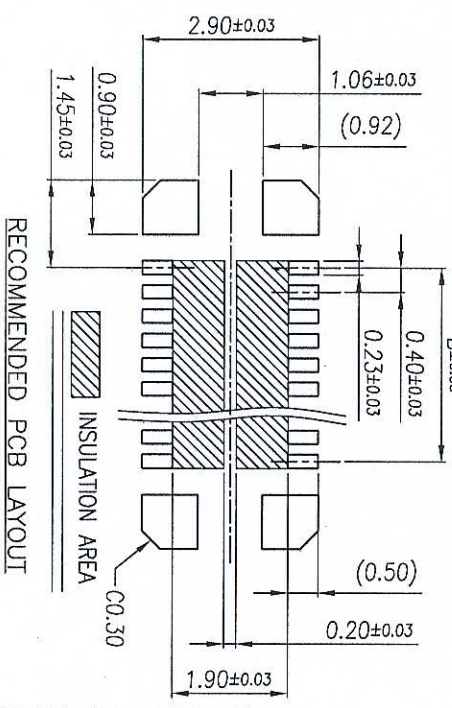

TABLE:

60	14.50	11.60	13.40	
50	12.50	9.60	11.40	
40	10.50	7.60	9.40	
34	9.30	6.40	8.20	
30	8.50	5.60	7.40	⊙
26	7.70	4.80	6.60	⊙
24	7.30	4.40	6.20	⊙
20	6.50	3.60	5.40	
16	5.70	2.80	4.60	
10	4.50	1.60	3.40	⊙
Pos No:	A	B	C	Available



LCN Shenzhen Linkconn Electronics Co., Ltd.

DIMENSION IN mm	TOLERANCE UNLESS OTHERWISE SPECIFIED	APR.	CHK.	DRG NO.	PROJ.	SCALE	SHEET	CUSTOMER DRAWING
.XX±0.25	X± 5'	APR	CHK	BAF04-24083-0500	PROJ.	N/A	1/2	DRAWING
.XXX±0.15	XX± 1'	DRG Kevin Wong		2012.08.07	SCALE	N/A	1/2	DRAWING

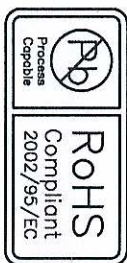

REV.	QTY	ECN. NO.	APR.	DATE
A	--	RC-12-2-019	Jason Su	2012.08.07

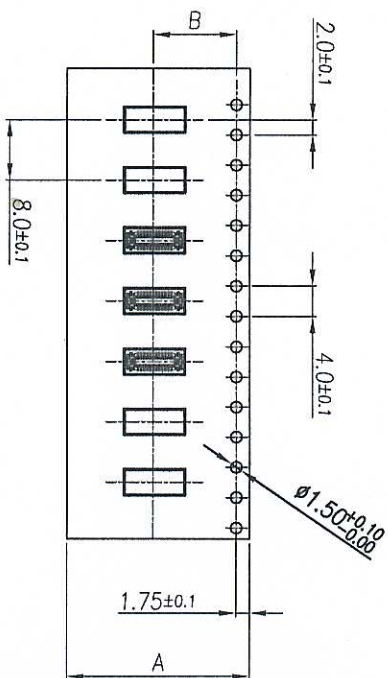
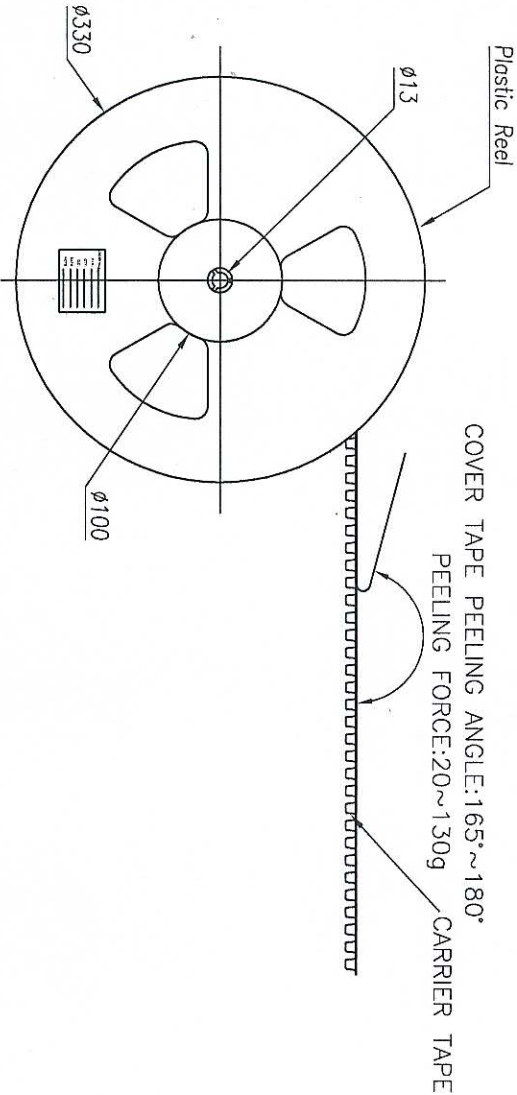
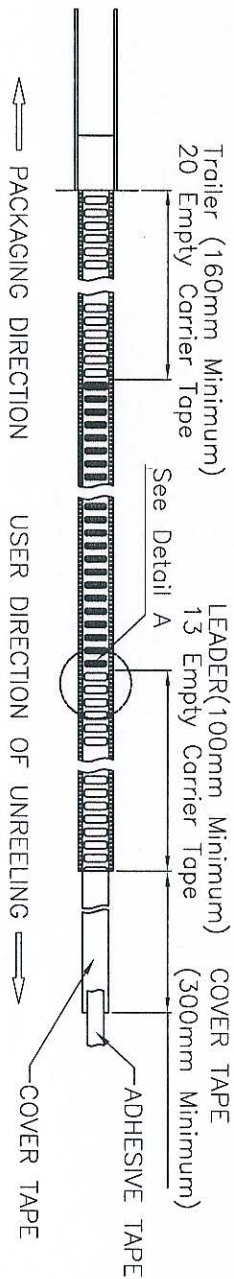

POS NO	DIM A	DIM B	QTY/REEL	REEL/CARTON	QTY/CARTON	CARTON SIZE
60						
50						
40	24.00	11.50	3000	10	30000	340*340*330
30						
26						
24						
20						
16	16.00	7.50	3000	14	42000	340*340*330
10						

DIMENSION IN mm		TOLERANCE UNLESS OTHERWISE SPECIFIED	
X±	0.35	X:±	1.5'
.XX±	0.25	.X:±	1.0'
.XXX±	0.15	.XX:±	0.5'



Shenzhen Linkcomm Electronics Co., Ltd.

APR	DRN Kevin Wang	2012.08.07
CHK		
TITLE	0.4mm PITCH BTB FEMALE MATING HEIGHT 0.8mm	
DWG NO.	BAF04-24083-0500	
PROJ.	SCALE	N/A
CUSTOMER DRAWING	SHEET	2/2
REV.	A	

Cameras Applications



Automotive Driver Pilot



Live Streaming



Video Conference



Eye Tracker Biometric Detection



Machine Vision



Agricultural Monitor



Night Vision Security



Drone and Sports Eagle Eyes



Interactive Pet Camera



YDS CAMERA MODULE

your best camera partner

Camera Module Pinout Definition Reference Chart

OmniVision	Sony	Samsung	On-Semi	Aptina	Himax	GalaxyCore	PixArt	SmartSens	Sensors
Pin Signal		Description							
DGND GND		ground for digital circuit							
AGND		ground for analog circuit							
PCLK DCK		DVP PCLK output							
XCLR PWDN XSHUTDOWN STANDBY		power down active high with internal pull-down resistor							
MCLK XVCLK XCLK INCK		system input clock							
RESET RST		reset active low with internal pull-up resistor							
NC NULL		no connect							
SDA SIO_D SIOD		SCCB data							
SCL SIO_C SIOC		SCCB input clock							
VSYNC XVS FSYNC		DVP VSYNC output							
HREF XHS		DVP HREF output							
DOVDD		power for I/O circuit							
AFVDD		power for VCM circuit							
AVDD		power for analog circuit							
DVDD		power for digital circuit							
STROBE FSTROBE		strobe output							
FSIN		synchronize the VSYNC signal from the other sensor							
SID		SCCB last bit ID input							
ILPWM		mechanical shutter output indicator							
FREQ		frame exposure / mechanical shutter							
GPIO		general purpose inputs							
SLASEL		I2C slave address select							
AFEN		CEN chip enable active high on VCM driver IC							
MIPI Interface									
MDN0 DN0 MD0N DATA_N DMO1N		MIPI 1st data lane negative output							
MDP0 DP0 MD0P DATA_P DMO1P		MIPI 1st data lane positive output							
MDN1 DN1 MD1N DATA2_N DMO2N		MIPI 2nd data lane negative output							
MDP1 DP1 MD1P DATA2_P DMO2P		MIPI 2nd data lane positive output							
MDN2 DN2 MD2N DATA3_N DMO3N		MIPI 3rd data lane negative output							
MDP2 DP2 MD2P DATA3_P DMO3P		MIPI 3rd data lane positive output							
MDN3 DN3 MD3N DATA4_N DMO4N		MIPI 4th data lane negative output							
MDP3 DP3 MD3P DATA4_P DMO4P		MIPI 4th data lane positive output							
MCN CLKN CLK_N DCKN		MIPI clock negative output							
MCP CLKP MCP CLK_P DCKN		MIPI clock positive output							
DVP Parallel Interface									
D0 DO0 Y0		DVP data output port 0							
D1 DO1 Y1		DVP data output port 1							
D2 DO2 Y2		DVP data output port 2							
D3 DO3 Y3		DVP data output port 3							
D4 DO4 Y4		DVP data output port 4							
D5 DO5 Y5		DVP data output port 5							
D6 DO6 Y6		DVP data output port 6							
D7 DO7 Y7		DVP data output port 7							
D8 DO8 Y8		DVP data output port 8							
D9 DO9 Y9		DVP data output port 9							
D10 DO10 Y10		DVP data output port 10							
D11 DO11 Y11		DVP data output port 11							

www.YDSCAM.com sales@ydscam.com Phone (WeChat, QQ): (+86) 177 2732 6718

All rights reserved @ YingDeShun Co. Ltd. Specifications subject to change without notice.

Camera Reliability Test

Reliability Inspection Item		Testing Method	Acceptance Criteria	
Category	Item			
Environmental	Storage Temperature	High 60°C 96 Hours	Temperature Chamber	No Abnormal Situation
		Low -20°C 96 Hours	Temperature Chamber	No Abnormal Situation
	Operation Temperature	High 60°C 24 Hours	Temperature Chamber	No Abnormal Situation
		Low -20°C 24 Hours	Temperature Chamber	No Abnormal Situation
	Humidity	60°C 80% 24 Hours	Temperature Chamber	No Abnormal Situation
	Thermal Shock	High 60°C 0.5 Hours Low -20°C 0.5 Hours Cycling in 24 Hours	Temperature Chamber	No Abnormal Situation
Physical	Drop Test (Free Falling)	Without Package 60cm	10 Times on Wood Floor	Electrically Functional
		With Package 60cm	10 Times on Wood Floor	Electrically Functional
	Vibration Test	50Hz X-Axis 2mm 30min	Vibration Table	Electrically Functional
		50Hz Y-Axis 2mm 30min	Vibration Table	Electrically Functional
		50Hz Z-Axis 2mm 30min	Vibration Table	Electrically Functional
	Cable Tensile Strength Test	Loading Weight 4 kg 60 Seconds Cycling in 24 Hours	Tensile Testing Machine	Electrically Functional
Electrical	ESD Test	Contact Discharge 2 KV	ESD Testing Machine	Electrically Functional
		Air Discharge 4 KV	ESD Testing Machine	Electrically Functional
	Aging Test	On/Off 30 Seconds Cycling in 24 Hours	Power Switch	Electrically Functional
	USB Connector	On/Off 250 Times	Plug and Unplug	Electrically Functional



Camera Inspection Standard

Inspection Item		Inspection Method	Standard of Inspection		
Category	Item				
Appearance	FPC/ PCB	Color	The Naked Eye	Major Difference is Not Allowed.	
		Be Torn/Chopped	The Naked Eye	Copper Crack Exposure is Not Allowed.	
		Marking	The Naked Eye	Clear, Recognizable (Within 30cm Distance)	
	Holder	Scratches	The Naked Eye	The Inside Crack Exposure is Not Allowed	
		Gap	The Naked Eye	Meet the Height Standard	
		Screw	The Naked Eye	Make Sure Screws Are Presented (If Any)	
		Damage	The Naked Eye	The Inside Crack Exposure is Not Allowed	
	Lens	Scratch	The Naked Eye	No Effect On Resolution Standard	
		Contamination	The Naked Eye	No Effect On Resolution Standard	
		Oil Film	The Naked Eye	No Effect On Resolution Standard	
		Cover Tape	The Naked Eye	No Issue On Appearance.	
	Function	Image	No Communication	Test Board	Not Allowed
			Bright Pixel	Black Board	Not Allowed In the Image Center
Dark Pixel			White board	Not Allowed In the Image Center	
Blurry			The Naked Eye	Not Allowed	
No Image			The Naked Eye	Not Allowed	
Vertical Line			The Naked Eye	Not Allowed	
Horizontal Line			The Naked Eye	Not Allowed	
Light Leakage			The Naked Eye	Not Allowed	
Blinking Image			The Naked Eye	Not Allowed	
Bruise			Inspection Jig	Not Allowed	
Resolution			Chart	Follows Outgoing Inspection Chart Standard	
Color			The Naked Eye	No Issue	
Noise			The Naked Eye	Not Allowed	
Corner Dark			The Naked Eye	Less Than 100px By 100px	
Color Resolution			The Naked Eye	No Issue	
Dimension	Height	The Naked Eye	Follows Approval Data Sheet		
	Width	The Naked Eye	Follows Approval Data Sheet		
	Length	The Naked Eye	Follows Approval Data Sheet		
	Overall	The Naked Eye	Follows Approval Data Sheet		

YDSCAM Package Solutions

YDS Camera Module



Complete with Lens Protection Film



Tray with Grid and Space



Place Cameras on the Tray



YDSCAM Package Solutions

Full Tray of Cameras

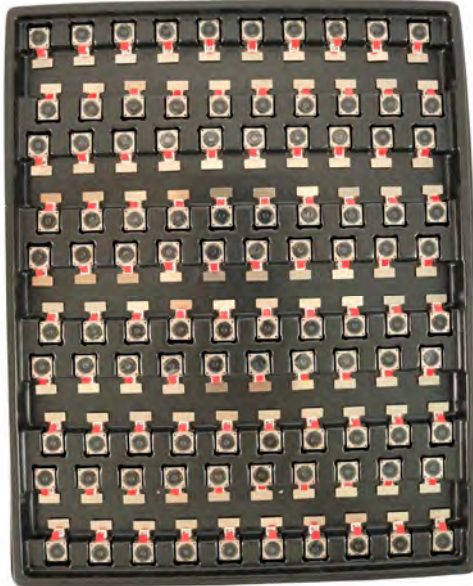

Cover Tray with Lid

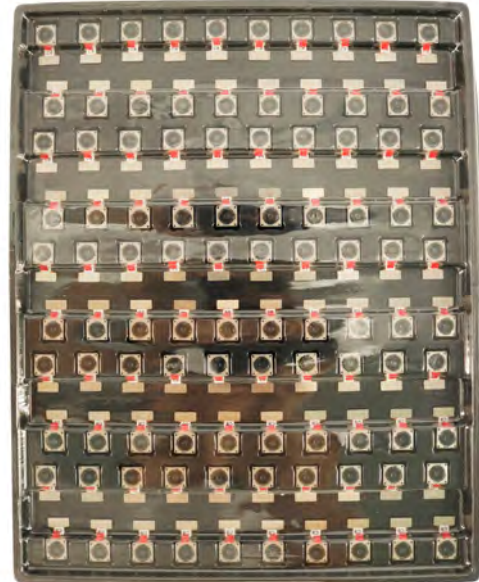

Place Tray into Anti-Static Bag



Vacuum the Anti-Static Bag



YDSCAM Package Solutions

Sealed Vacuum Anti-Static Bag with Labels

1. Model and Description 2. Quantity 3. Manufacturing Date Code 4. Caution



YDSCAM Package Solutions

Place Foam Sheets Between Tray Bags



Foam Sheets are Larger Than Trays



Place Foam Sheets and Trays into Box



Foam Sheets are Tightly Fitting in Box



Seal the Carbon Box



Label the Carbon Shipping Box





YDSCAM Package Solutions

USB Camera Module

Complete with Lens Protection Film



Place Camera Sample into Anti-Static Bag

Place USB Cameras into Tray



Seal the Tray with Anti-Static Bag

Label the Carbon Shipping Box



YDSCAM Package Solutions

Place Camera Sample into Anti-Static Bag



Place Connectors into Anti-Static Bag



Label the Sample Bags



Place Connectors into Reel



Place Samples into the Carbon Box



Place Connectors into the Carbon Box





YDS CAMERA MODULE

your best camera partner

Company YDSCAM

YingDeShun Co. Ltd. (YDS) was established in 2017, a next-generation technology driven manufacturer specialized in research, design, and produce of audio and video products. YDS is occupying 20,000 square feet automated plants with 100 employees of annual throughput 30,000,000 units cameras.

YDS provides OEM, ODM design, contract manufacturing, and builds the camera products. You may provide the requirements to us, even with a hand draft, our sales and engineering work together to meet your needs. We consider ourselves your last-term partner in developing practical and innovative solutions.

Our team covers everything from initial concept development to mass produced product. YDS specializes in customized camera design, raw material, electronic engineering, firmware/software development, product testing, and packing design. Our experienced strategic supply systems offer a robust and dependable manufacturing capacity for orders of various sizes.

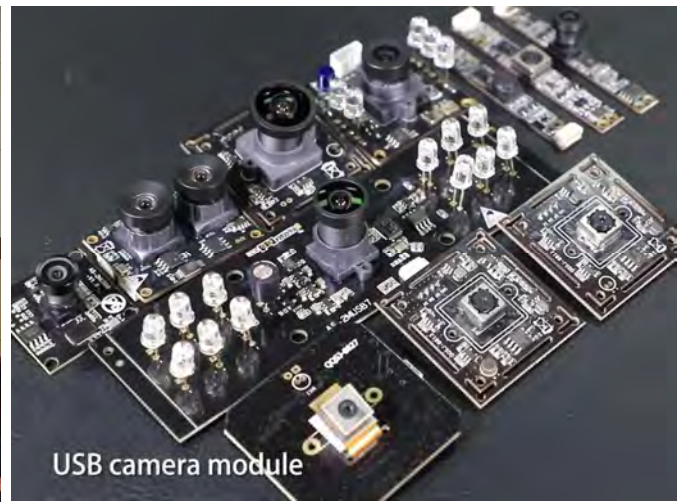

Limited Warranty

YDS provides the following limited warranty if you purchased the Product(s) directly from YDS company or from YDS's website www.YDSCAM.com. Product(s) purchased from other sellers or sources are not covered by this Limited Warranty. YDS guarantees that the Product(s) will be free from defects in materials and workmanship under normal use for a period of one (1) year from the date you receive the product ("Warranty Period").

For all Product(s) that contain or develop material defects in materials or workmanship during the Warranty Period, YDS will, at its sole option, either: (i) repair the Product(s); (ii) replace the Product(s) with a new or refurbished Product(s) (replacement Product(s) being of identical model or functional equivalent); or (iii) provide you a refund of the price you paid for the Product(s).

This Limited Warranty of YDS is solely limited to repair and/or replacement on the terms set forth above. YDS is not reliable or responsible for any subsequent events.



www.YDSCAM.com sales@ydscom.com Phone (WeChat, QQ): (+86) 177 2732 6718

All rights reserved @ YingDeShun Co. Ltd. Specifications subject to change without notice.



YDS CAMERA MODULE

your best camera partner

YDS Strength

Powerful Factory



Professional Service



Promised Delivery



www.YDSCAM.com sales@ydscam.com Phone (WeChat, QQ): (+86) 177 2732 6718

All rights reserved @ YingDeShun Co. Ltd. Specifications subject to change without notice.